

2 1/4" Door - OG Profiles
Please Choose One

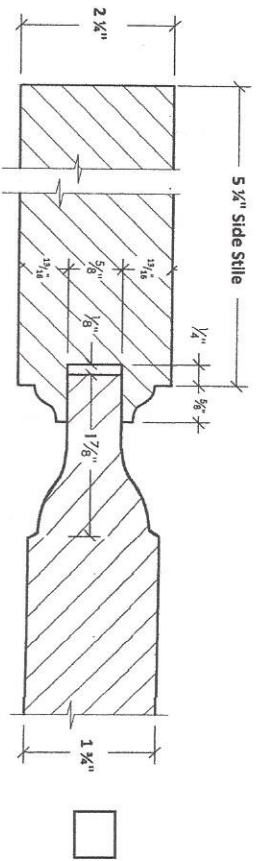

PC 3080 Panel

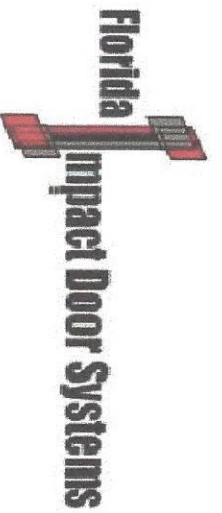
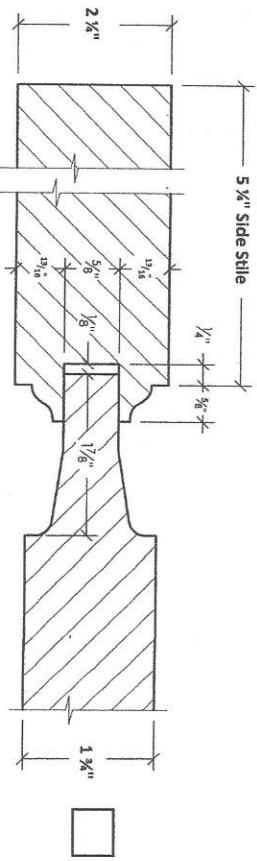

PC 3000 Panel

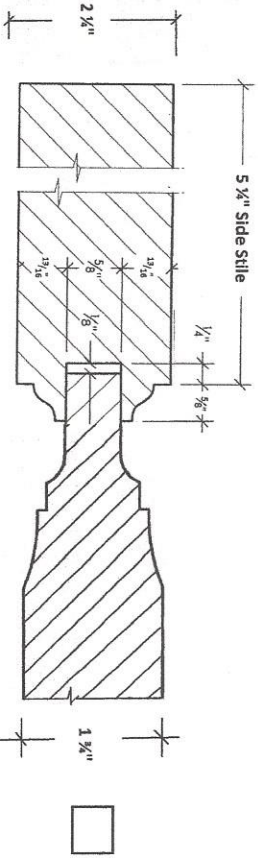

Colonial Panel

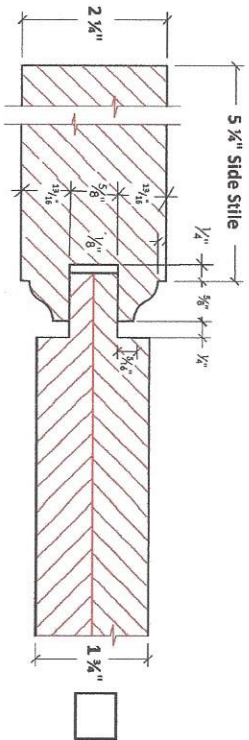

Standard Shaker Panel

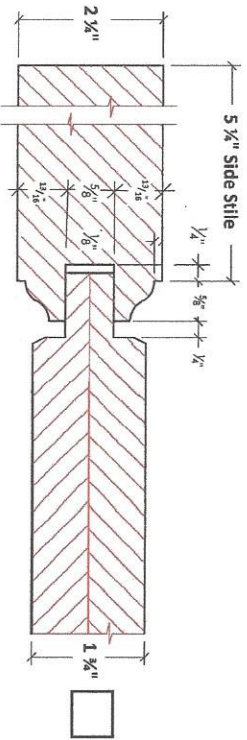

Eased Edge Shaker Panel

Signature For Approval: _____

Date: _____

2 1/4" Door - SQ Profiles
 Please Choose One

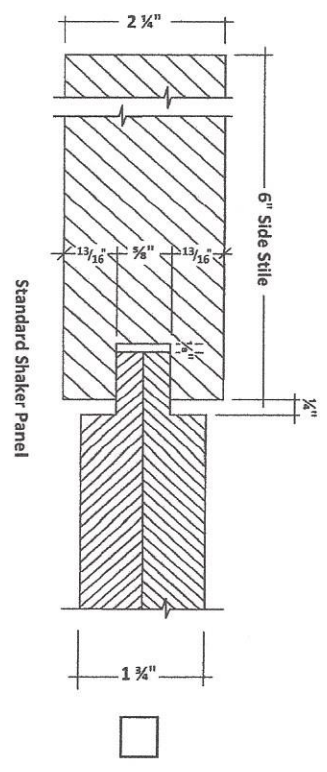
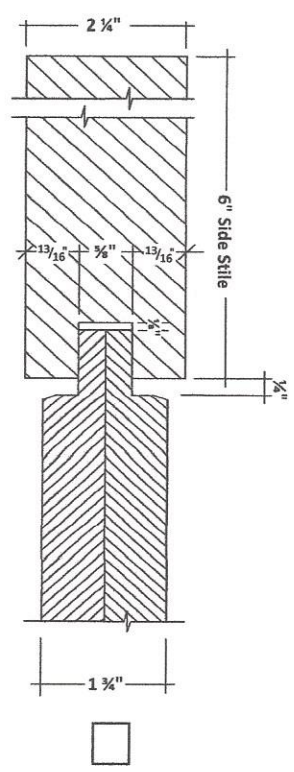
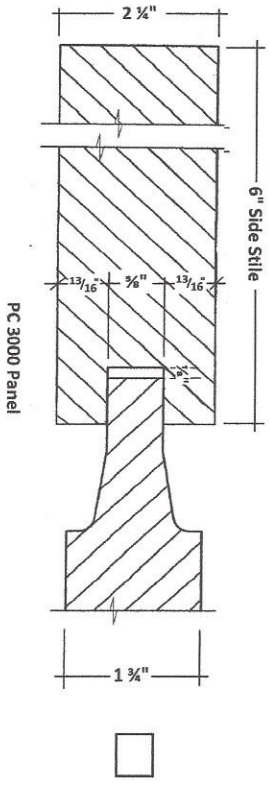
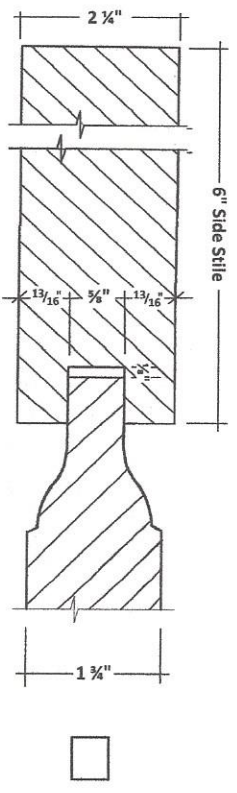
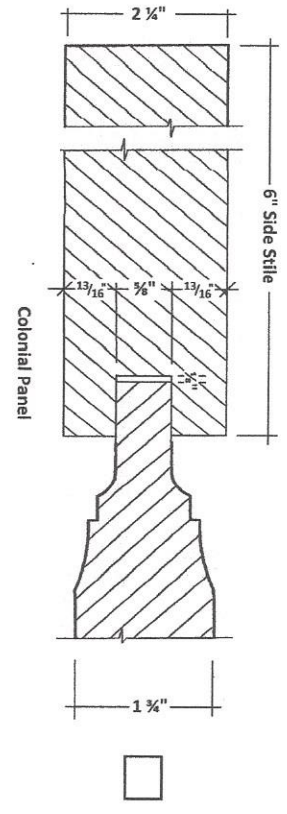

Signature For Approval: _____

Date: _____

2 1/4" Door - SQ Profiles - V-Groove
Please Choose One

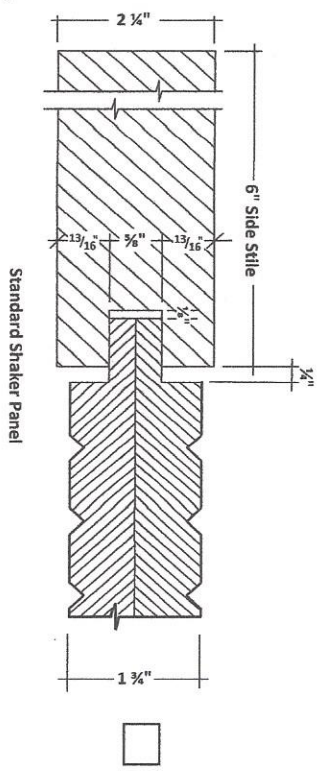
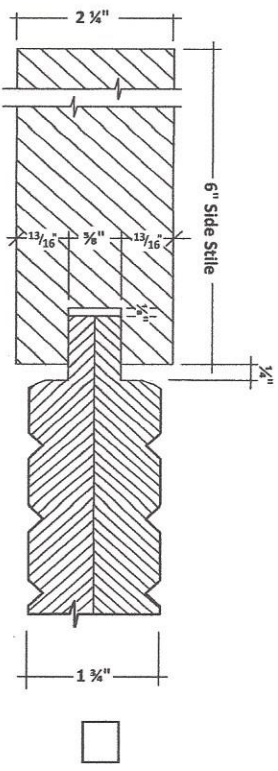
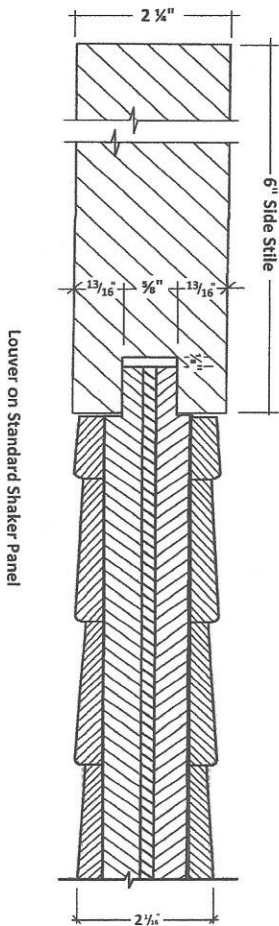
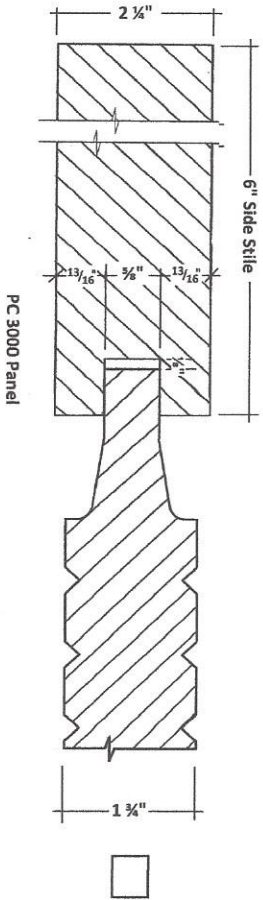
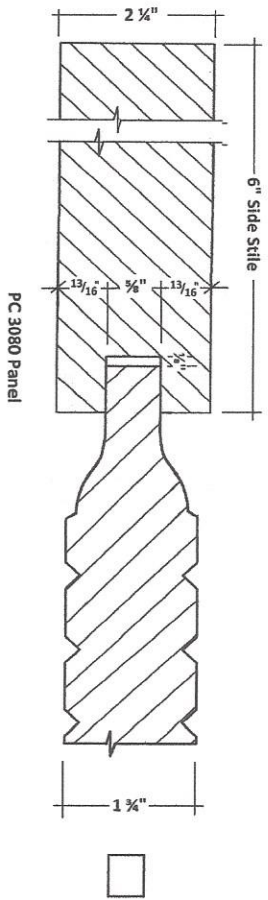

Signature For Approval: _____

Date: _____